

BG **Инструкции за инсталиране**
Внимание! Преди да пристъпите към инсталирането, прочетете информацията за безопасност в Ръководството за потребителя. **Забележка:** Изображенията представят само общ преглед на продукта. Вътрешното оборудване може да се различава.

CA **Pokyny k instalaci**

Atenció! Abans de començar la instal·lació, llegiu la informació de seguretat al Manual d'usuari. **Nota:** El gràfic mostra només una vista general del producte. L'equip intern pot ser diferent.

CS **Pokyny k instalaci**

Upozornění! Před začátkem instalace si přečtete bezpečnostní informace v návodu k použití. **Poznámka:** Vyobrazení představuje pouze obecný přehled spotřebiče. Vnitřní vybavení se může lišit.

DA **Installationsvejledning**

Vigtigt! Læs brugsanvisningens instruktioner vedrørende sikkerhed, før installationen påbegyndes. **Bemærk:** Grafikken giver kun et generelt overblik over produktet. Det indvendige udstyr kan variere.

DE **Montageanweisung**

Achtung! Lesen Sie vor Beginn der Installation die Sicherheitshinweise in der Gebrauchsanweisung. **Hinweis:** Die Abbildungen stellen nur eine allgemeine Produktübersicht dar. Die Innenausstattung kann abweichen.

EL **Οδηγίες εγκατάστασης**

Προειδοποίηση! Πριν συνεχίσετε με την εγκατάσταση, διαβάστε τις πληροφορίες ασφάλειας στο εγχειρίδιο χρήστη. **Σημείωση:** Τα σχέδια αναπαριστούν μόνο τη γενική επισκόπηση του προϊόντος. Ο εσωτερικός εξοπλισμός ενδέχεται να διαφέρει.

EN **Installation Instruction**

Warning! Before proceeding with installation, read the safety information in the User Manual. **Note:** The graphics present only general product overview. The internal equipment might differ.

ES **Instrucciones de instalación**

¡Atención! Antes de realizar la instalación, lea la información de seguridad del Manual del usuario. **Nota:** los gráficos presentan únicamente una descripción general del producto. El equipo interno puede variar.

ET **Paigaldusjuhised**

Hoiatus! Enne paigaldamist lugege läbi kasutusjuhendis olevad ohutusjuhised. **Märkus:** Joonisel on toodud



INSTALLATION MANUAL

Warning! Before proceeding with installation, read the Safety Information leaflet.

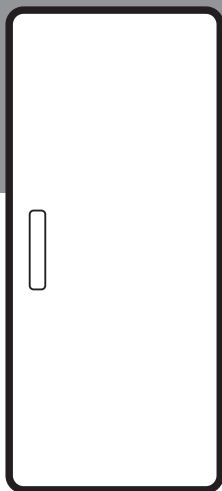

www.youtube.com/aeg

How to install your AEG door on door cabinet fridge



www.youtube.com/electrolux

How to install your Electrolux door on door cabinet fridge



vaid toote üldine ülevaade. Seadme sisemus võib olla erinev.

FI Asennusohjeet

Varoituis! Ennen kuin aloitat asennuksen, lue käyttöohjeen sisältämät turvallisuusohjeet. **Huomautus:** Kuvat esittävät ainoastaan yleisen tuotteen kuvauksen. Sisällä oleva laitteisto voi poiketa kuvista.

FR Instructions d'installation

Attention ! Veuillez lire les consignes de sécurité que contient la Notice d'utilisation avant d'installer l'appareil. **Remarque :** les graphiques donnent uniquement une présentation générale du produit. L'équipement interne peut varier.

HR Upute za instalaciju

Upozorenje! Prije instalacije pročitajte sigurnosne informacije u Uputama za uporabu. **Napomena:** Slika predstavlja samo općeniti prikaz proizvoda. Unutarnja oprema može se razlikovati.

HU Üzembe helyezési útmutató

Vigyázat! Mielőtt továbblépne az üzembe helyezésessel, olvassa el a biztonsági információkat a felhasználói kézikönyvben. **Megjegyzés:** Az ábra csupán az általános termék megjelenítést szolgálja. A készülék tényleges kialakítása ettől eltérő lehet.

IT Istruzioni di installazione

Attenzione! Prima di procedere all'installazione, leggere le istruzioni di sicurezza contenute nel Libretto Istruzioni. **Nota:** Le immagini offrono solo una panoramica generale del prodotto. La dotazione interna potrebbe essere diversa.

KK Орнату туралы нұсқаулық

Ескерту! Құрылғыны орнатардың алдында пайдаланушы нұсқаулығындағы қауіпсіздік туралы ақпаратты оқыңыз. **Ескерім:** Суреттерде құрылғының жалпы сыртқы көрінісі ғана бейнеленген. Құрылғы әр түрлі болуы мүмкін.

LT Įrengimo instrukcija

Įspėjimas! Prieš montuodami perskaitykite saugos informaciją naudojimo instrukcijoje. **Pastaba:** Paveikslėliai skirti tik bendrajai gaminių apžvalgai. Vidaus įranga gali skirtis.

LV Uzstādīšanas norādījumi

Brīdinājums! Pirms turpināt uzstādīšanu, izlasiet lietotāja rokasgrāmatā ietvertu drošības informāciju. **Piezīme:**

šie attēli sniedz tikai vispārēju izstrādājuma pārskatu. Iekšējās iekārtas var atšķirties.

MK Упатство за монтажа

Предупредување! Пред да почнете со монтажа, во Прирачникот прочитајте ги упатствата за безбедна работа. **Напомена:** Сликите го претставуваат само општиот преглед на производот. Внатрешната опрема може да се разликува.

NL Installatie-instructies

Waarschuwing! Lees de veiligheidsinformatie in de gebruikershandleiding voordat u met de installatie begint. **Opmerking:** De afbeelding geeft alleen een algemeen productoverzicht. De interne apparatuur kan verschillen.

NO Monteringsanvisning

Advarsel! Les sikkerhetsinformasjonene i bruksanvisningen før du begynner installasjonen. **Merk:** Grafikken presenterer kun generell produktoversikt. Medfølgende utstyr kan avvike.

PL Wskazówki dotyczące instalacji

Ostrzeżenie! Przed rozpoczęciem instalacji należy przeczytać informacje dotyczące bezpieczeństwa podane w Instrukcji obsługi. **Uwaga:** ilustracja przedstawia tylko ogólny wygląd urządzenia. Wewnętrzne wyposażenie może się różnić od widocznego na ilustracji.

PT Instruções de instalação

Atenção! Antes de continuar a instalação, leia as informações de segurança no Manual de Utilizador. **Nota:** As ilustrações apresentam apenas uma visão geral do produto. O equipamento interno pode ser diferente.

RO Instrucțiuni de instalare

Atenție! Înainte de a trece la instalare, citiți informațiile privind siguranța din Manualul Utilizatorului. **Observație:** Graficele indică doar o prezentare generală a produsului. Echipamentul intern poate fi diferit.

RU Указания по установке

Внимание! Перед тем как приступить к установке, прочтите информацию по технике безопасности в руководстве пользователя. **Примечание:** Графическое изображение представляет собой лишь общий обзор изделия. Состав содержащегося внутри оборудования может различаться.

SK Pokyny na inštaláciu

Upozornenie! Pred inštaláciou si prečítajte bezpečnostné pokyny v návode na používanie. **Poznámka:** Obrázky predstavujú iba všeobecné zobrazenie výrobku. Vnútorne vybavenie sa môže líšiť.

SL Navodila za namestitve

Opozorilo! Pred nadaljevanjem z namestitvijo preberite varnostna navodila v navodilih za uporabo. **Opomba:** Na sliki je predstavljen samo splošni pregled izdelka. Notranja oprema se lahko razlikuje.

SQ Udhëzime Instalimi

Paralajmërim! Përpara se të kryeni instalimin, lexoni të dhënat e sigurisë në Manualin e Përdorimit. **Shënim:** Figurat paraqesin vetëm pamjen e përgjithshme të produktit. Pajisjet e brendshme mund të ndryshojnë.

SR Упутство за инсталирање

Упозорење! Пре него што приступите инсталирању уређаја, прочитајте информације о безбедности у Упутству за употребу. **Напомена:** Слика представља само општи преглед производа. Унутрашња опрема се може разликовати.

SV Installationsanvisningar

Varning! Läs säkerhetsanvisningarna i bruksanvisningen innan du fortsätter med installationen. **OBS!** Bilderna visar bara en allmän produktöversikt. Den inre utrustningen kan vara annorlunda.

TR Montaj Talimatları

Uyarı! Montaj işleminde başlamadan önce, kullanma kılavuzundaki güvenlik bilgilerinizi okuyunuz. **Not:** Bu görseller ürüne ilişkin sadece genel bakış sağlamaktadır. İç donanımlar farklılık gösterebilir.

UK Інструкція з установки

Увага! Перед початком встановлення прочитайте інформацію щодо безпеки у Посібнику користувача. **Примітка:** Ілюстрації представляють лише загальний вигляд продукту. Внутрішнє оснащення може відрізнятися.

AR تحذیر! اقرأ معلومات الأمان في دليل المستخدم قبل متابعة التثبيت. ملاحظة: الرسومات تقدم فقط نظرة عامة على المنتج. قد تختلف المعدات الداخلية.



10 mm

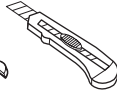

Ø 2 mm

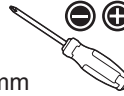

a

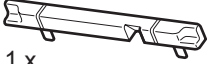

1 x

b



1 x

c

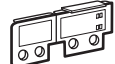

1 x

d



1 x

f



2 x

g



6 x

h



2 x

i



8 x

Ø3,5 - 13 mm

j



4 x

k₁



1 x

k₂



1 x

L = 22 mm



1 x

m



2 x

n



1 x

o 18 x



Ø3,5 - 13 mm

p 4 x



Ø3,5 - 16 mm



L/L

i

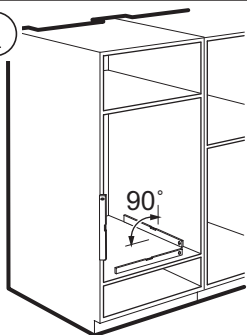

90°

i

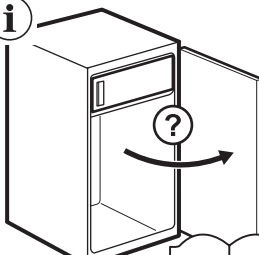

?

→ 10

i

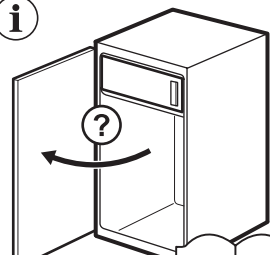

?

→ 1

1

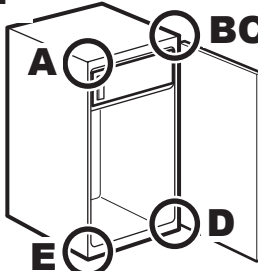

A

BC

E

D

1A

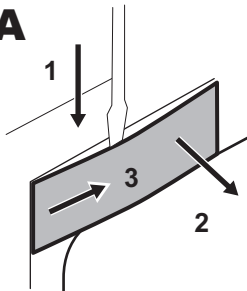

1

2

1B

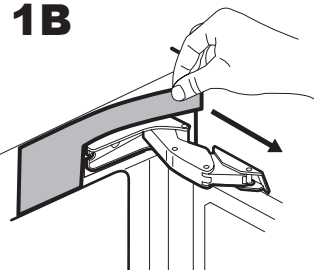

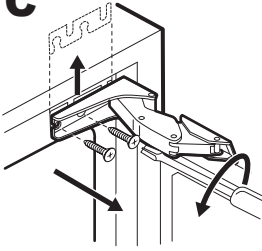
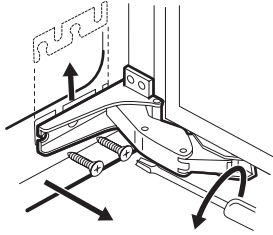
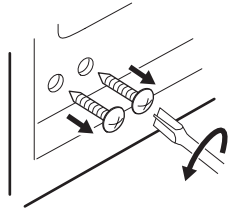
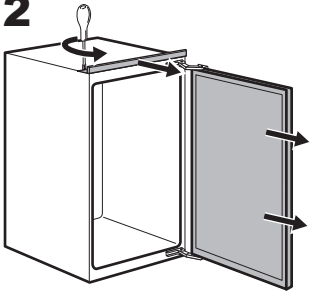
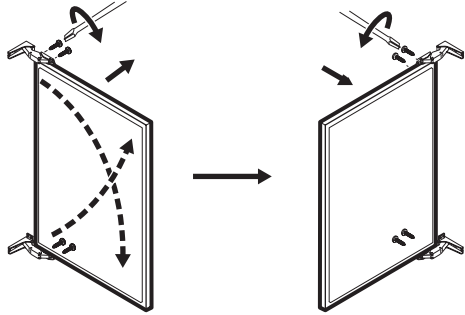
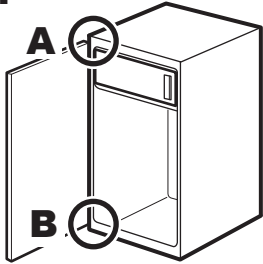
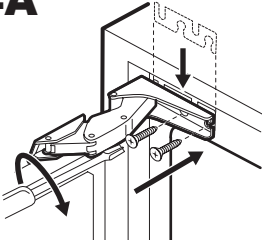
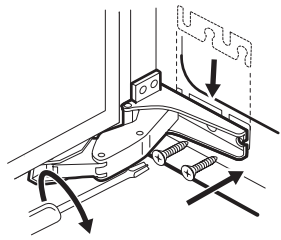
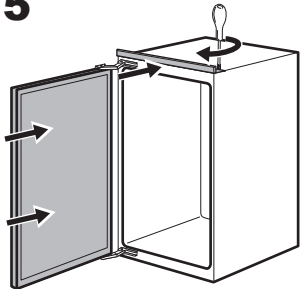
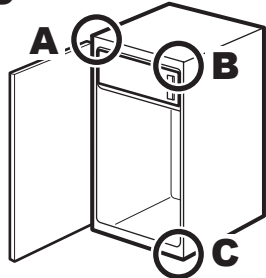
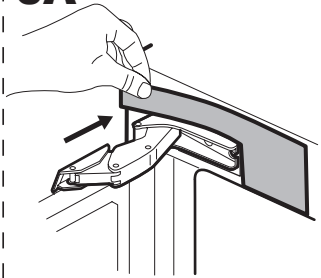
1C**1D****1E****2****3****4****4A****4B****5****6****6A**

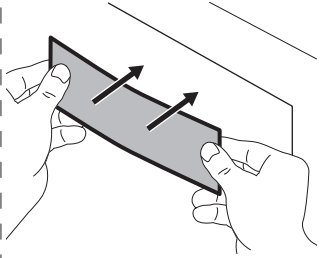
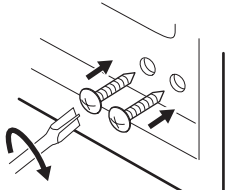
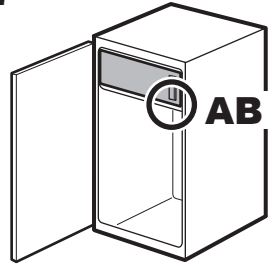
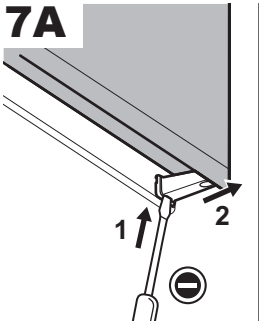
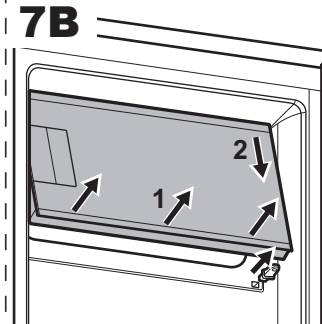
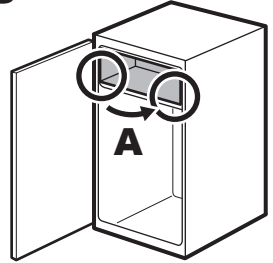
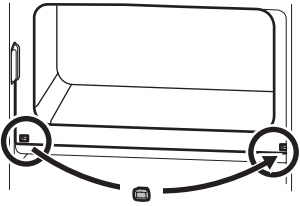
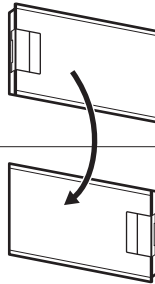
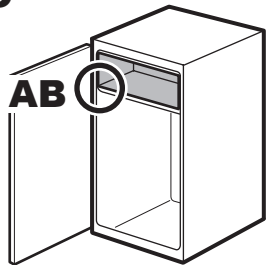
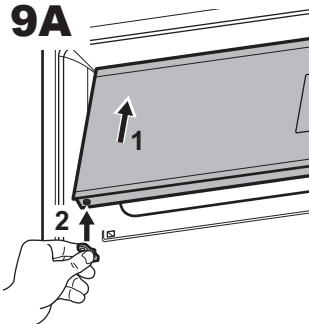
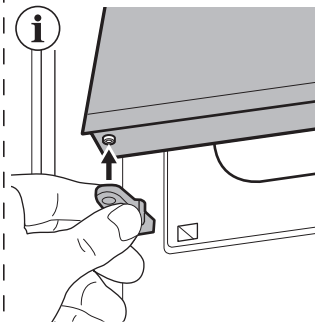
6B**6C****7****7A****7B****8****8A****i****9****9A****i****9B**